Real-Time Monitoring of the Impact of Cascaded Wavelength-Selective Switches in Digital Coherent Receivers

Dario Pileri^{1,4}, Antonello Nespola², Fabrizio Forghieri³,

Stefano Piciaccia³ and Gabriella Bosco¹

¹ DET, Politecnico di Torino, Italy

² LINKS Foundation, Italy

³ Cisco Photonics Italy

⁴ INRiM, Italy

- **Flexible grid networks** → signals pass through multiple reconfigurable optical add-drop multiplexers (ROADMs), which employ wavelength-selective switches (WSSs).
- **Bandwidth-variable transceivers** (BVTs) with flexible symbol rate and modulation format enable the optimization of the capacity by balancing the optical filtering tolerance and the required signal-to-noise ratio (SNR) → **the cascaded WSS filtering penalty needs to be constantly monitored.**
- In this work, we explore the feasibility and accuracy of a **simple real-time monitoring** technique of the filtering penalty due to cascaded WSSs, using only the information which is available in the digital receiver.

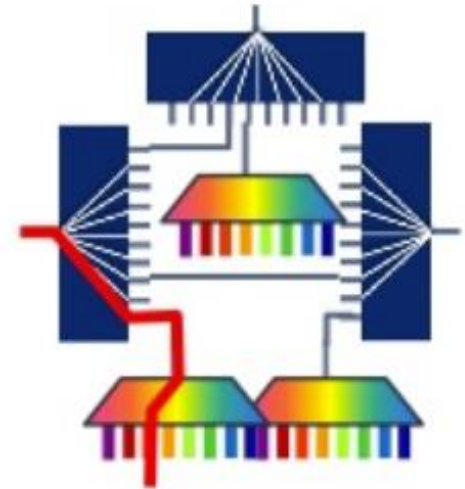

- The taps of the receiver adaptive equalizer can be used to monitor several propagation effects, such as chromatic dispersion, PMD and PDL [1,2].
- The transfer function $H_{eq}(f)$ of the equalizer is inversely proportional to the transfer function $H_{WSS}(f)$ of the cascaded WSSs \rightarrow can be used to monitor the impact of the WSSs filtering effects

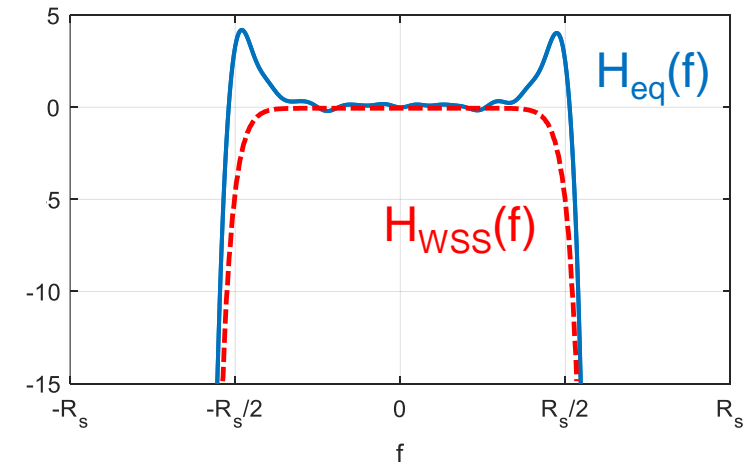
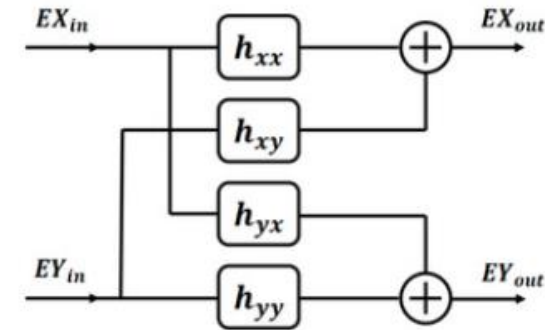

1. F.N. Hauske et al., "Optical Performance Monitoring in Digital Coherent Receivers," JLT, **27**(16), 3623-3631 (2009)
2. G. Bosco et al., "Joint DGD, PDL and Chromatic Dispersion Estimation in Ultra-Long-Haul WDM Transmission Experiments with Coherent Receivers", ECOC 2010, Torino (Italy), paper Th. 10.A.2.

Evolution of equalizer transfer function

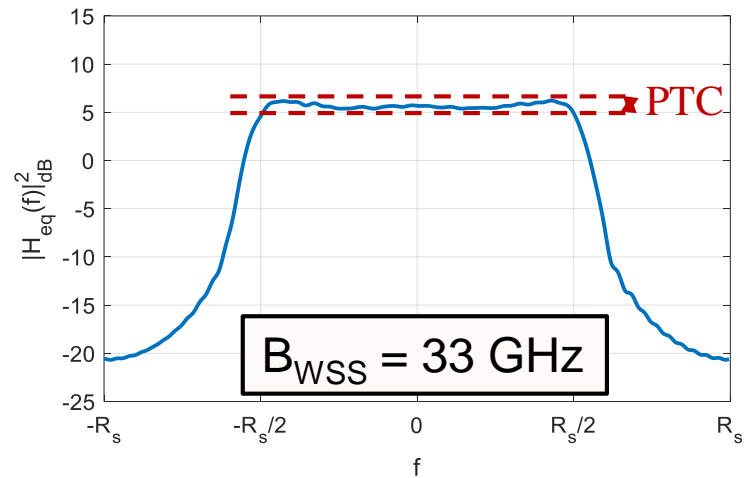
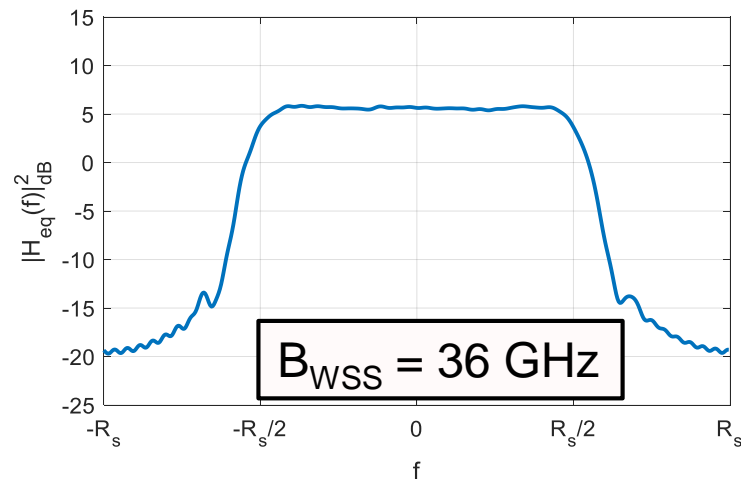

$R_s = 32 \text{ Gbaud}$

PTC = peak-to-center ratio

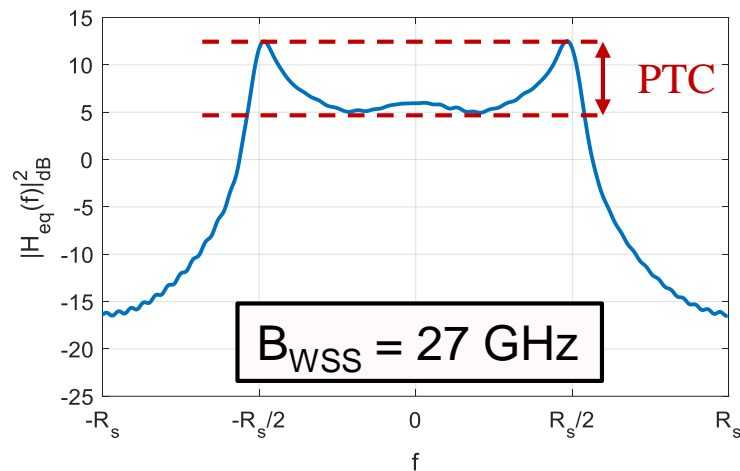
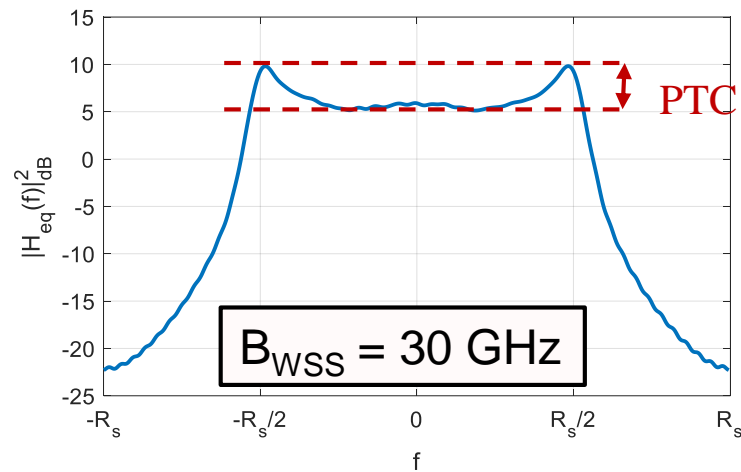

- Higher PTC → noise enhancement → reduced SNR

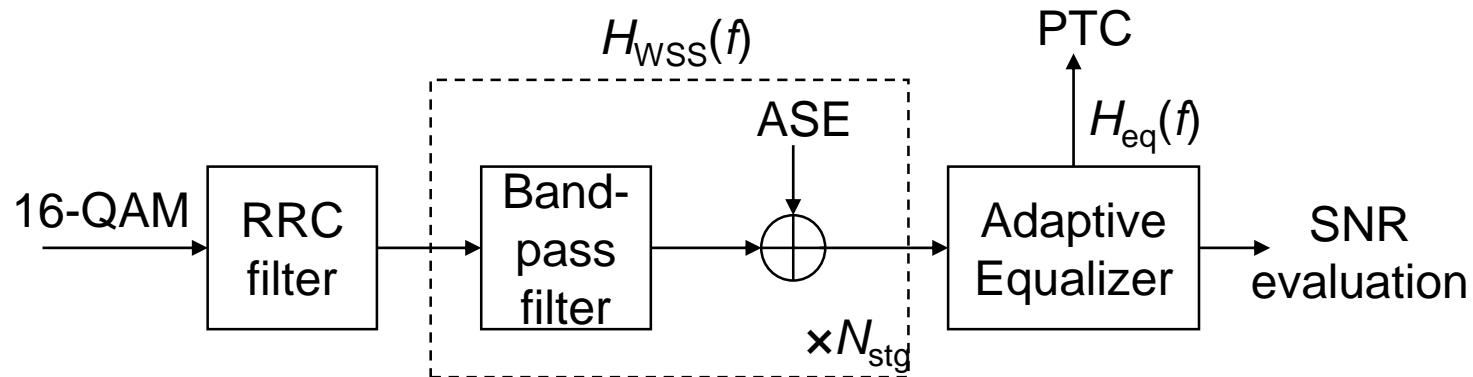

- 32 Gbaud 16-QAM
- Roll-off 0.2
- WSS: 4th order Super-Gaussian filter
- LMS adaptive equalizer (50 taps)
- Combined bandwidth of the cascaded WSSs varied between 25 and 37 GHz, with 1-GHz steps
- 1000 Monte-Carlo random realizations of the filters.
- For each filter realization:
 - the center frequency was set to $f_0 + \Delta f$, where f_0 is the center propagation frequency of the signal;
 - the 3-dB bandwidth was set to $B_0 + \Delta B$, where B_0 the nominal value of the filter bandwidth;
 - Δf and ΔB are uniformly distributed random variables in the interval ± 1 GHz.

Simulation results – 1 and 2 stages



1 stage

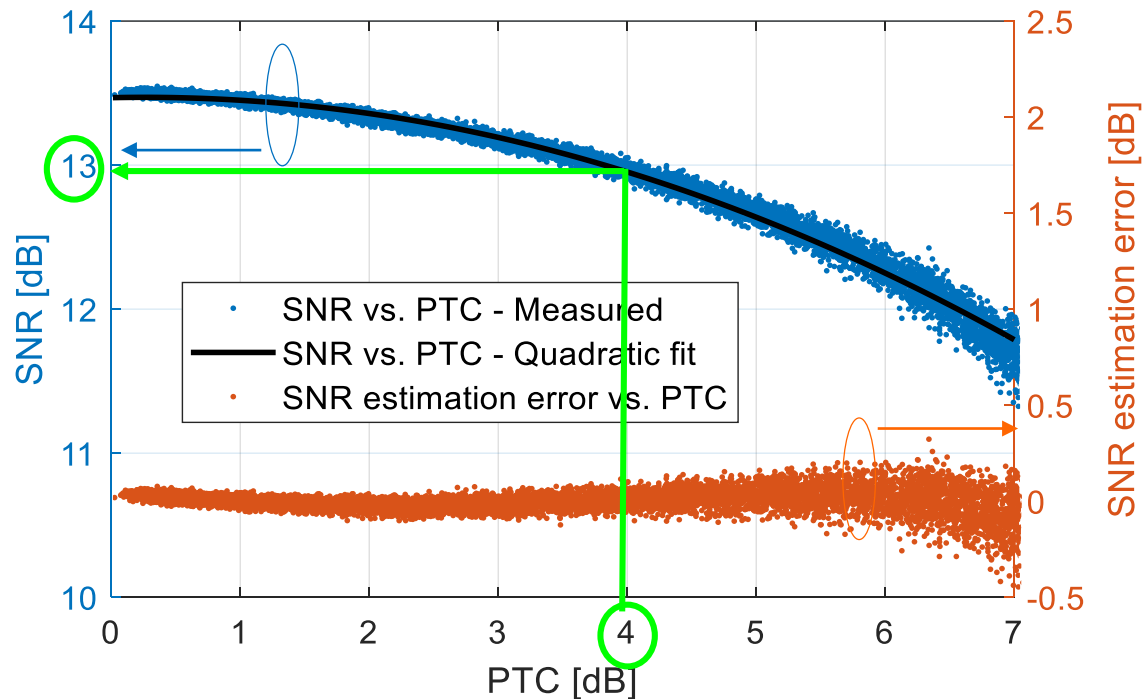

2 stages

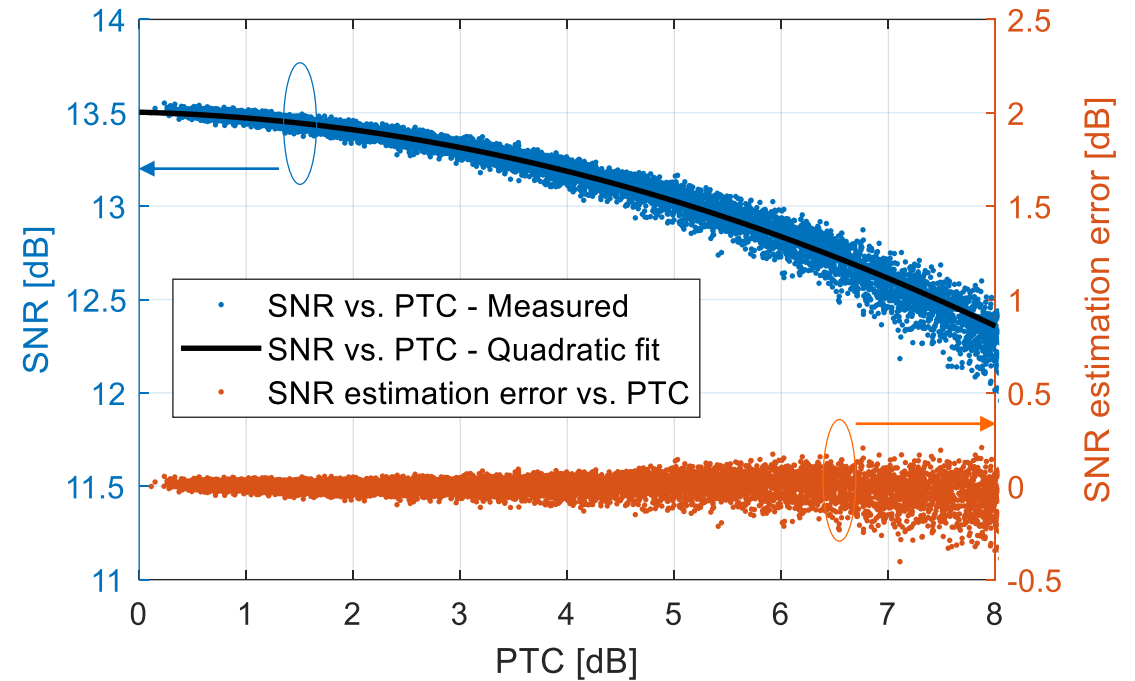

- 15,000 point (1000 realizations for 15 values of filter bandwidth)
- The solid line has been obtained by a quadratic fit on the first 2,000 simulation points.
- The estimation error (difference between the real SNR and the one inferred using the quadratic fit) has been evaluated considering the remaining 13,000 points.

Simulation results – 3 and 4 stages



3 stages

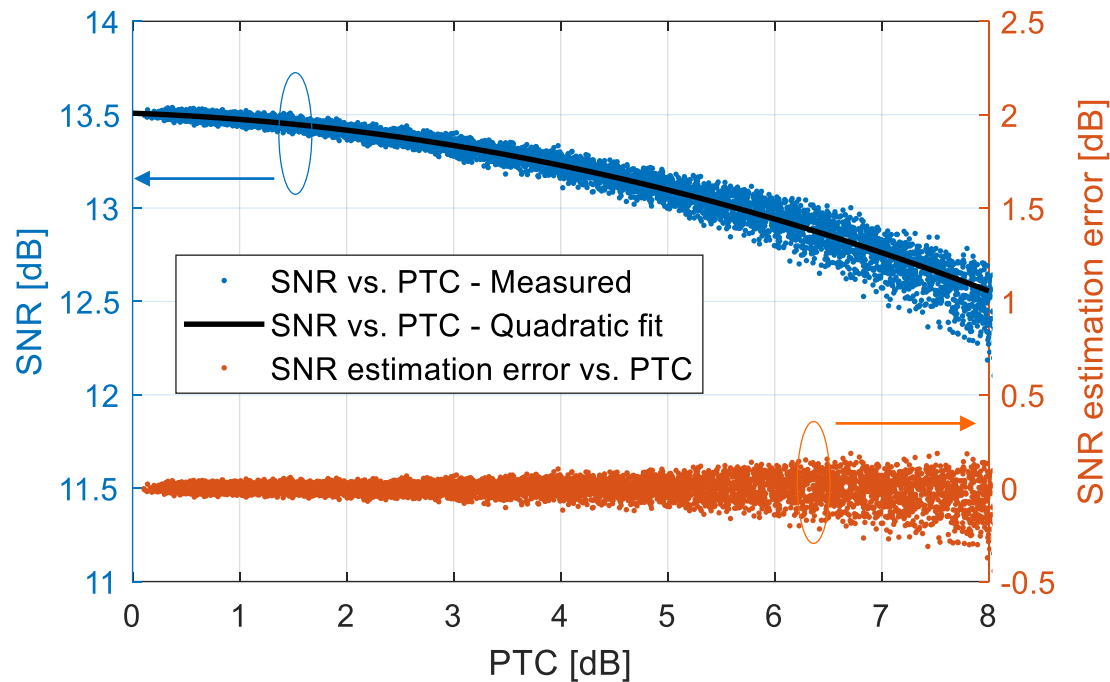

4 stages

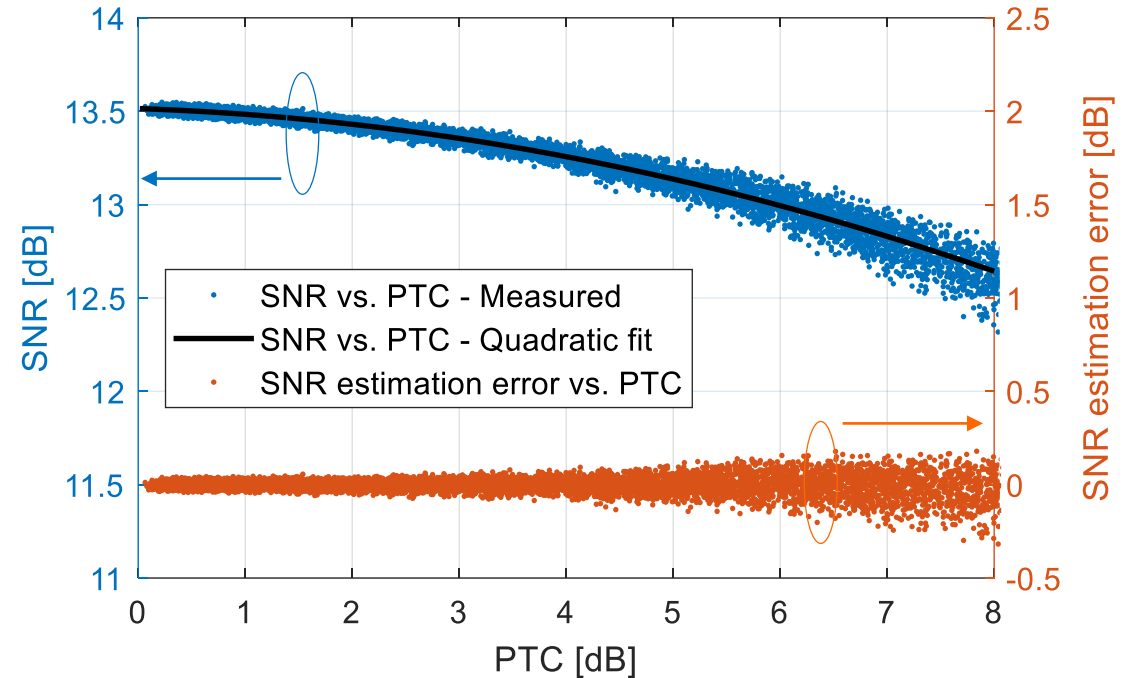

- 15,000 point (1000 realizations for 15 values of filter bandwidth)
- The solid line has been obtained by a quadratic fit on the first 2,000 simulation points.
- The estimation error (difference between the real SNR and the one inferred using the quadratic fit) has been evaluated considering the remaining 13,000 points.

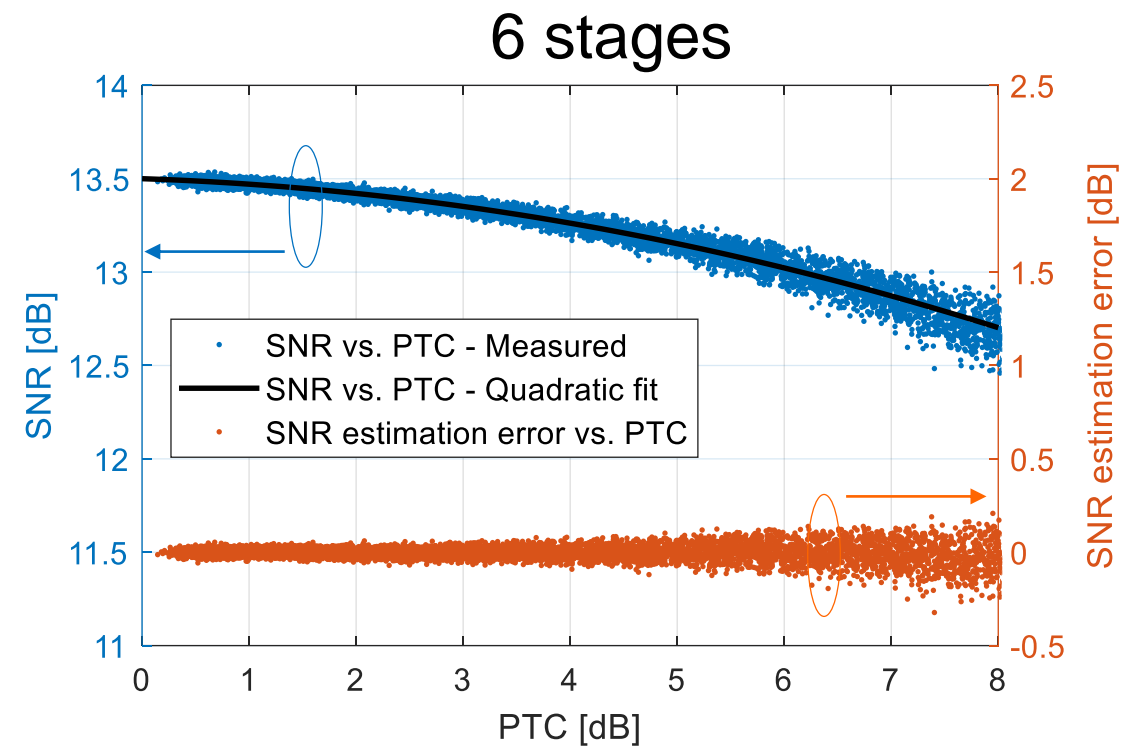
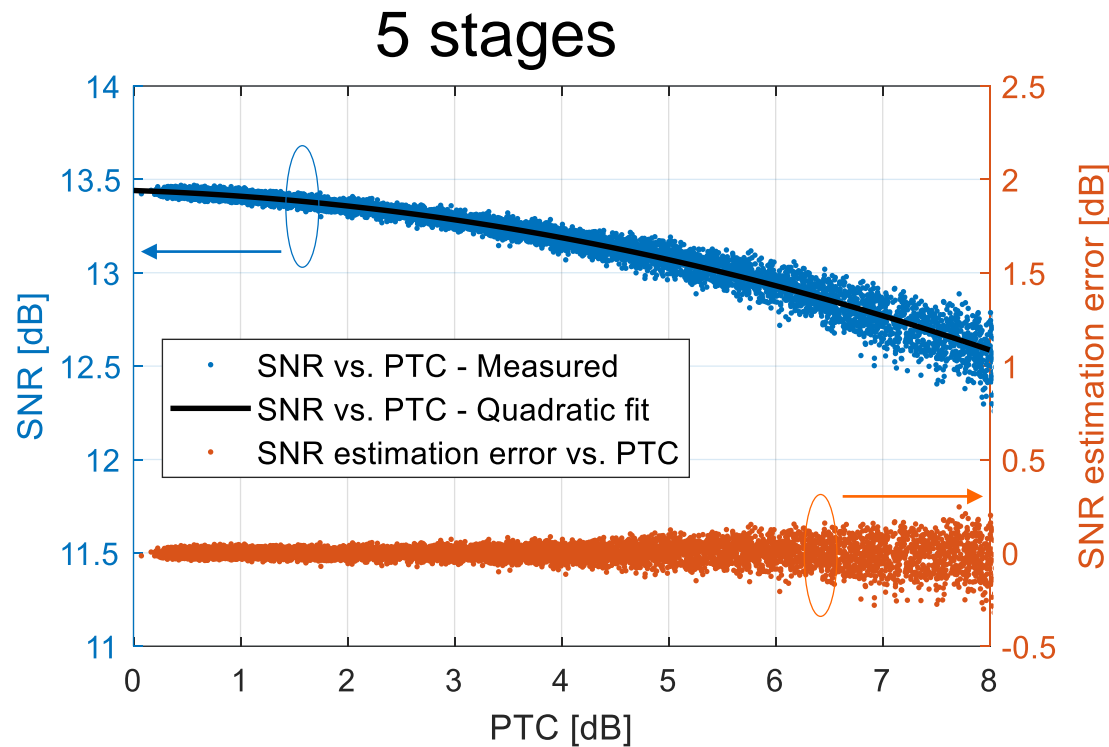

- 15,000 point (1000 realizations for 15 values of filter bandwidth)
- The solid line has been obtained by a quadratic fit on the first 2,000 simulation points.
- The estimation error (difference between the real SNR and the one inferred using the quadratic fit) has been evaluated considering the remaining 13,000 points.

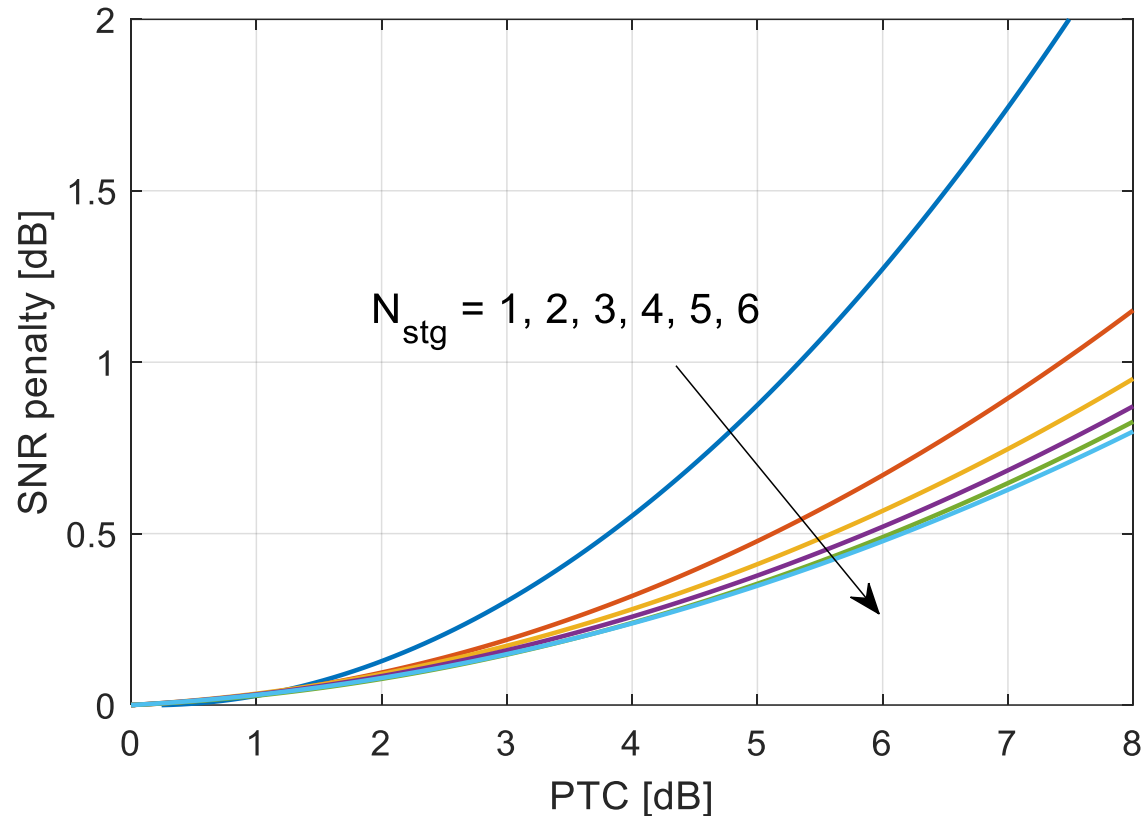

- The single-stage case, albeit not realistic, represents a “worst-case” scenario.
- With the increasing number of stages, the SNR penalty vs. PTC decreases.
 - In multistage scenarios part of the noise added along the link is subsequently filtered by the WSSs, and consequently the effect of its amplification by the adaptive equalizer is partially mitigated.
- For a number of stages higher than 4, all the curves start to converge → in a realistic situation with several WSSs, the SNR-PTC relationship does not strongly depend on the actual number of WSSs.

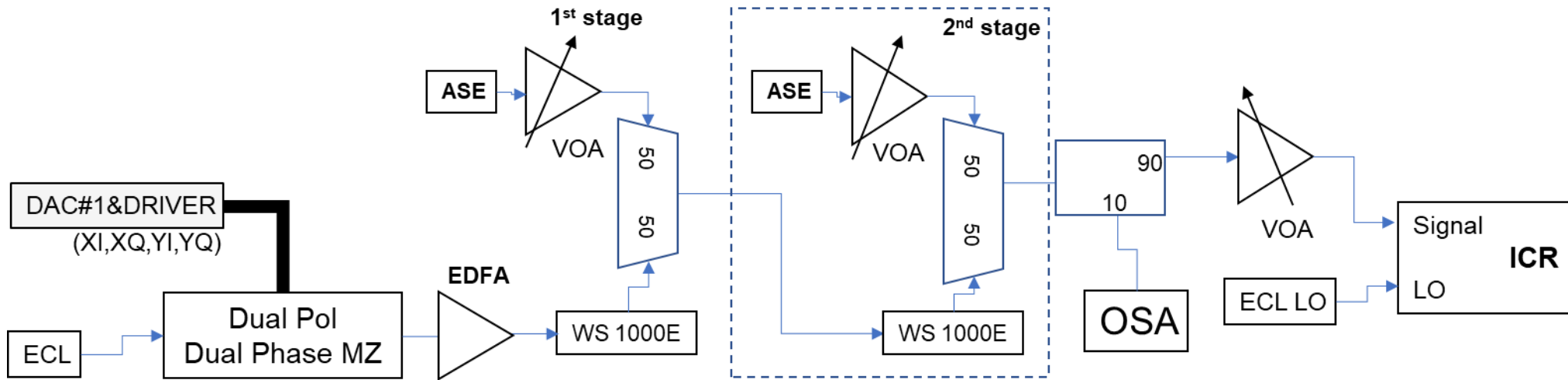

- 32 Gbaud 16-QAM, roll-off 0.2
- Same DSP as in simulations
- Filter bandwidth varied from 20 to 50 GHz, in steps of 1 GHz

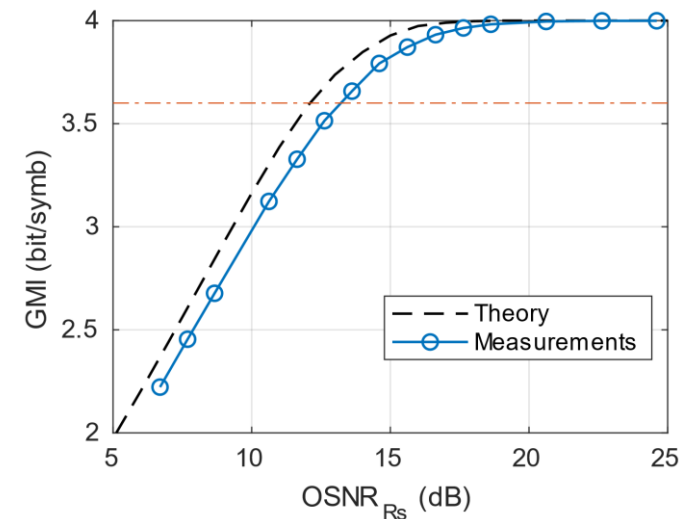

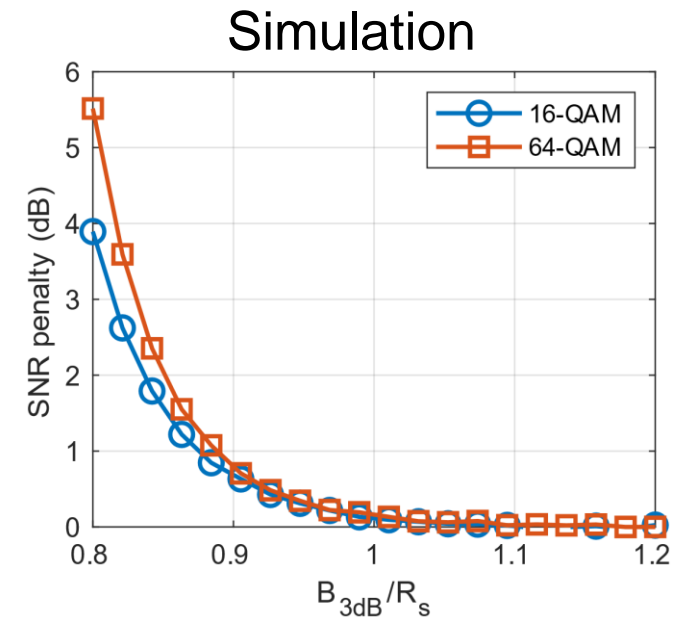
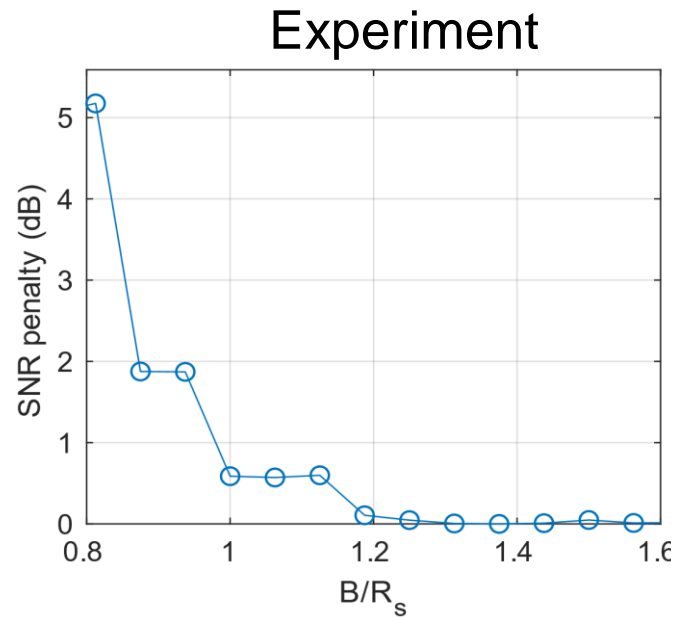
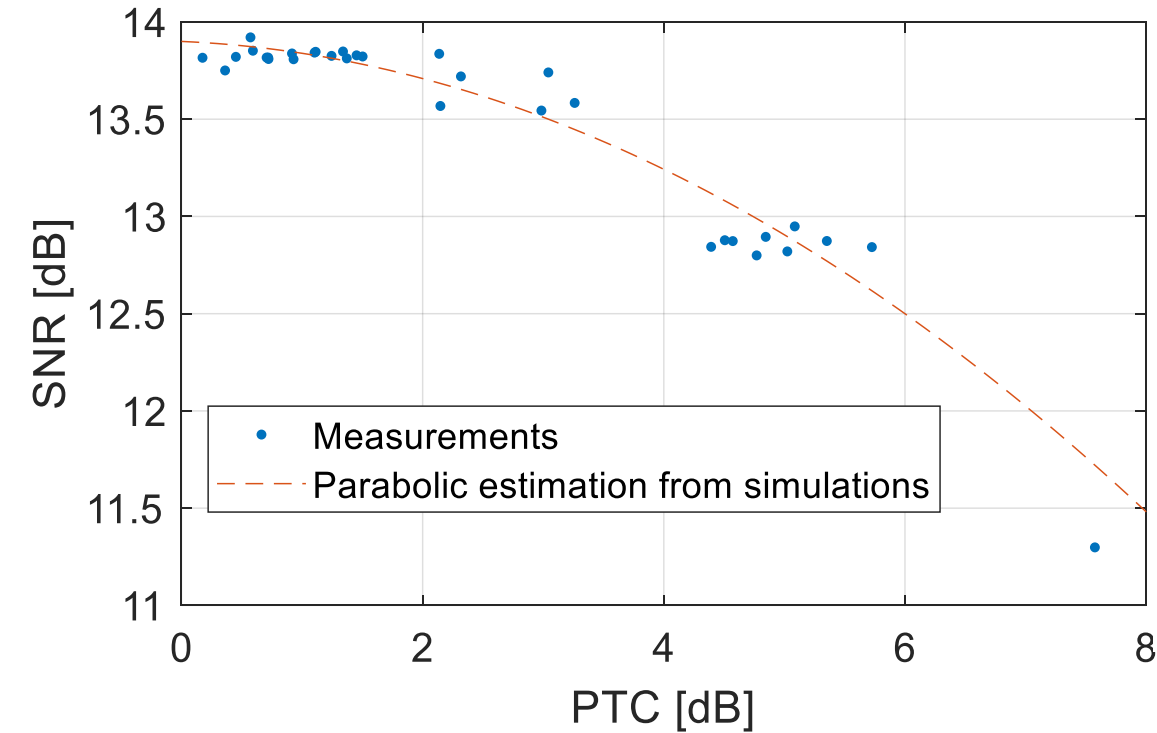

- Despite of some random fluctuations of the actual value of the filters bandwidth used in the experimental measurements, caused by the limited resolution of the waveshapers, the semi-analytical parabolic estimations well fit the experimental results.

Experimental results – 1 and 2 stages

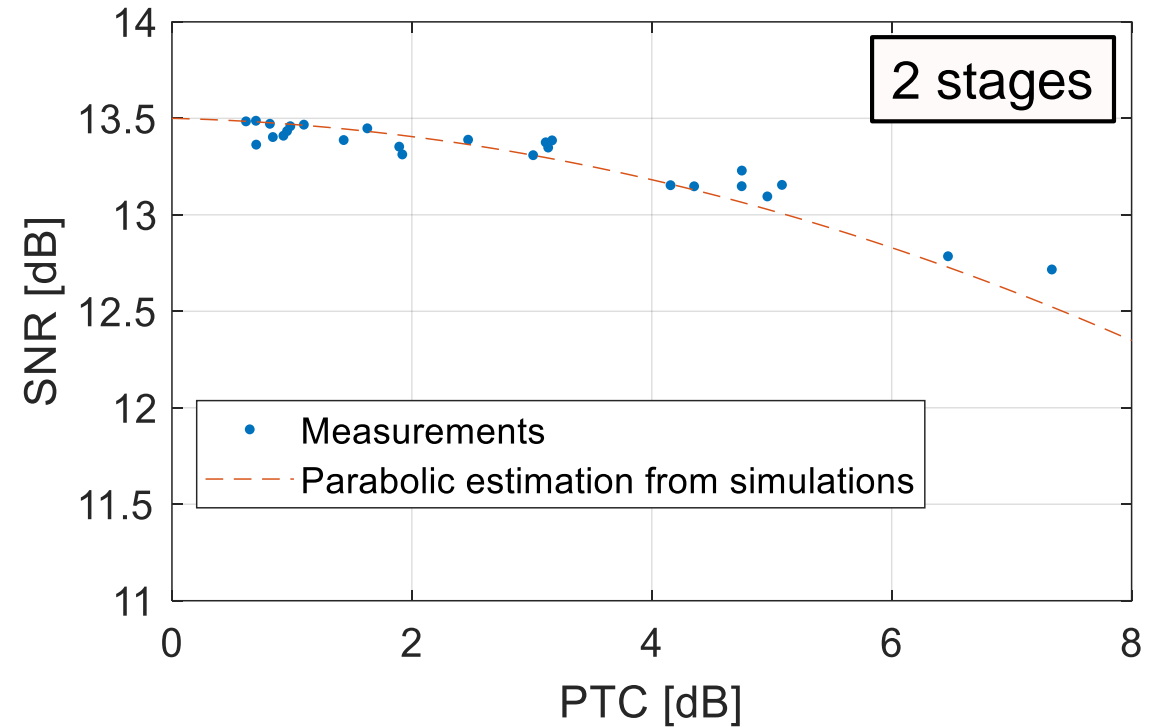
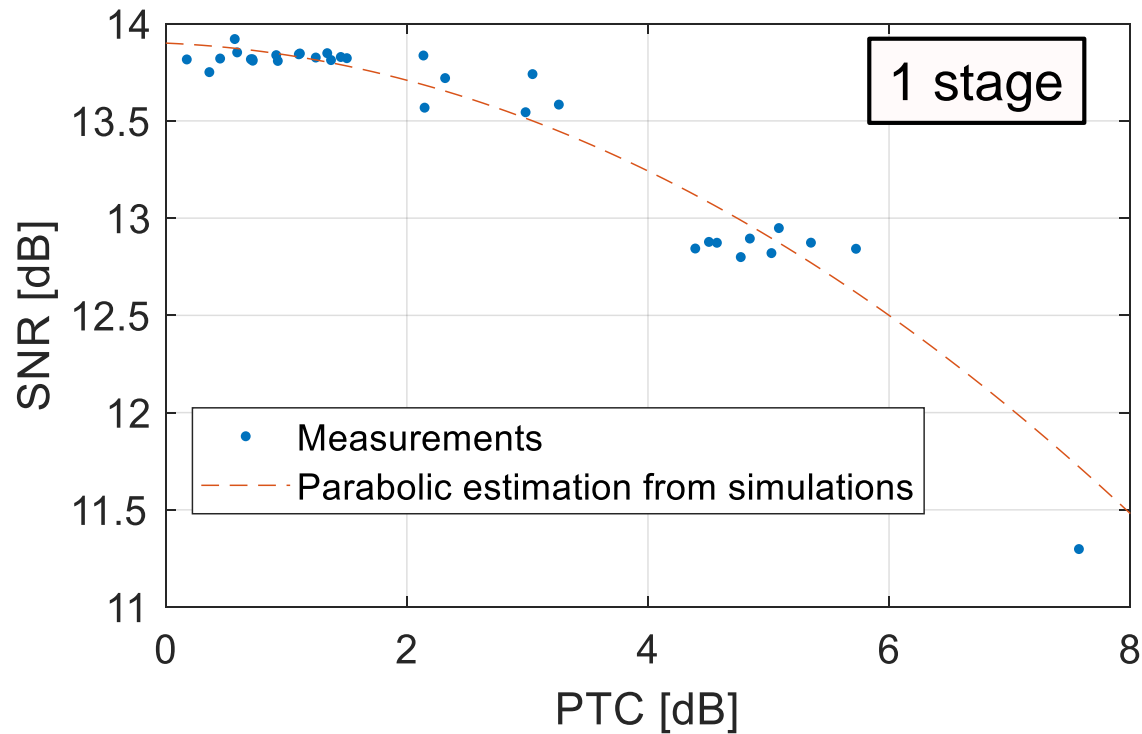

- Follow-up experiments with a higher number of stages confirmed the results, though highlighting a threshold effect which appears when the filtering is too tight and the equalizer is not able to properly recover the original spectrum.

- We presented a low-complexity scheme to extract the real-time filtering penalty from the adaptive equalizer coefficients in the coherent receiver DSP.
- The proposed algorithm, tested in both simulations and experiments, is potentially able to detect the filtering penalty with an arbitrary number of cascaded WSSs, as long as the equalizer is able to properly recover the original spectrum.

Real-Time Monitoring of the Impact of Cascaded Wavelength-Selective Switches in Digital Coherent Receivers

Dario Pileri^{1,4}, Antonello Nespola², Fabrizio Forghieri³,

Stefano Piciaccia³ and Gabriella Bosco¹

¹ DET, Politecnico di Torino, Italy

² LINKS Foundation, Italy

³ Cisco Photonics Italy

⁴ INRiM, Italy
